

Product Specification

25.78Gb/s SR SFP28 850nm 100m
Optical Transceiver

P/N: 25G-SFP-SR



Features

- Hot Pluggable SFP28 form factor
- Operating data rate 25.78Gbps
- Single +3.3V power supply
- Duplex LC-UPC connector
- Max power dissipation <1.0W
- Up to 70m transmission distance on OM3 MMF
- Up to 100m transmission distance on OM4 MMF
- 850nm VCSEL laser
- PIN receivers
- 25GAUI C2M Electrical Interface
- Built-in CDR
- Built-in digital diagnostic function
- Commercial temperature range 0°C to 70°C

Compliance

- SFP MSA
- Compliant with SFP+ Electrical MSA SFF-8431
- Compliant with SFP+ Mechanical MSA SFF-8432
- SFF-8472
- IEEE 802.3ae
- RoHS

Applications

- Switches with SFP+ ports
- Router with SFP+ Ports
- Server or Network Adapter Card
- Optical Transmission System
- Other devices with SFP+ Ports

Description

The 25G-SFP-SR is a high-performance, multi-mode optical transceiver module designed for 25 Gigabit Ethernet applications. It supports data rates of up to 25.78 Gbps and is optimized for short-reach communication, with a maximum transmission distance of up to 100 meters on OM4 multi-mode fiber (MMF) and 70 meters on OM3 MMF. This SFP28 module operates at a wavelength of 850nm, making it ideal for high-speed data center interconnects, enterprise networks, and other short-distance applications. Its duplex LC interface ensures easy integration into existing network setups, providing reliable and efficient data transmission.

The 25G-SFP-SR is fully compliant with industry standards, including SFF-8472, SFF-8431, and SFF-8432, ensuring interoperability with a wide range of networking equipment. It features advanced digital diagnostics monitoring (DDM) capabilities, accessible via a 2-wire serial interface, enabling real-time monitoring of key parameters such as temperature, voltage, and optical power. With low power consumption and a compact SFP28 form factor, the 25G-SFP-SR is a cost-effective and energy-efficient solution for high-speed networking needs. Its robust design and compliance with environmental standards make it a dependable choice for modern network operators seeking to enhance their infrastructure with reliable, high-performance connectivity.

Product performance Specifications

1、 Basic Product Characteristics

Parameter	Symbol	Min	Typ.	Max	Unit
Storage Temperature	T _s	-40	-	+85	°C
Supply Voltage	V _{CC}	0	-	3.6	V
Relative Humidity	RH	5	-	85	%
Operating Case Temperature	T _C	0	-	70	°C
Power Supply Voltage	V _{CC}	3.135	3.3	3.47	V
Power Supply Current	I _{CC}			288	mA
Power Dissipation	PD	-	-	1000	mW
Data Rate			25.78125		Gbps
Transmission Distance(OM4)	-		-	100	m

2、Product Optical and Electrical Characteristics

Parameter	Symbol	Min	Typ.	Max	Unit
Transmitter					
Center Wavelength	λ_C	840	850	860	nm
RMS Spectral Width	σ			0.6	nm
Optical Power for TX DISABLE	P_{OFF}			-30	dBm
Output average power	P_{AVG}	-7.9		1.9	dBm
Optical Modulation Amplitude	OMA	-6.4		3	dBm
Extinction Ratio	ER	2			dB
Relative Intensity Noise	RIN			-128	dB/Hz
Optical Return Loss Tolerance	ORL			12	dB
Transmitter Dispersion Penalty	TDP			4.3	dB
Optical Eye Mask		5			%
Tx Input Diff Voltage	V_I	180		700	mV
Tx Fault	V_{oL}	-0.3		0.4	V
	I_{oH}	-50		37.5	μA
Tx_Disable	V_{IL}	-0.3		0.8	V
	V_{IH}	2		$V_{CC}+0.3$	V
Receiver					
Center Wavelength	λ_C	840	850	860	nm
Receiver Sensitivity ₁	R_{sens}			-10.3	dBm
Los Assert	$LosA$	-30			dBm
Los Dessert	$LosD$			-13	dBm
Los Hysteresis	$LosH$	0.5			dB
Overload	P_{in}	2.4			dBm
Receiver Reflectance				-6	dB
Operating Data Rate			10.3125		Gbps
Rx Output Diff Voltage	V_o	300		900	mV
Rx_LOS ₂	V_{oL}	-0.3		0.4	V
	I_{oH}	-50		37.5	μA
RS0 and RS1	V_{IL}	-0.3		0.8	V
	V_{IH}	2		$V_{CC}+0.3$	V

Note1: Receiver sensitivity is informative. shall be measured with conformance test signal for BER=1x10⁻⁵.

Note2: Measured with a 4.7 k Ω load pulled up to V_{CC} .

Recommended Host Board Power Supply Circuit

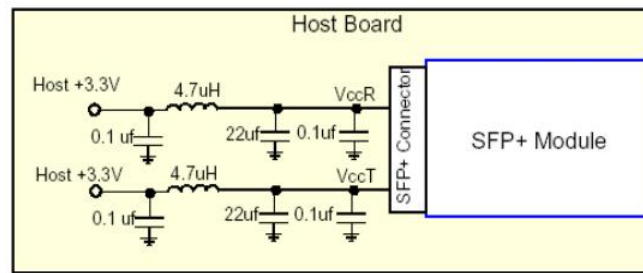

Figure 1: Recommended Host Board Power Supply Circuit

Recommended Interface Circuit

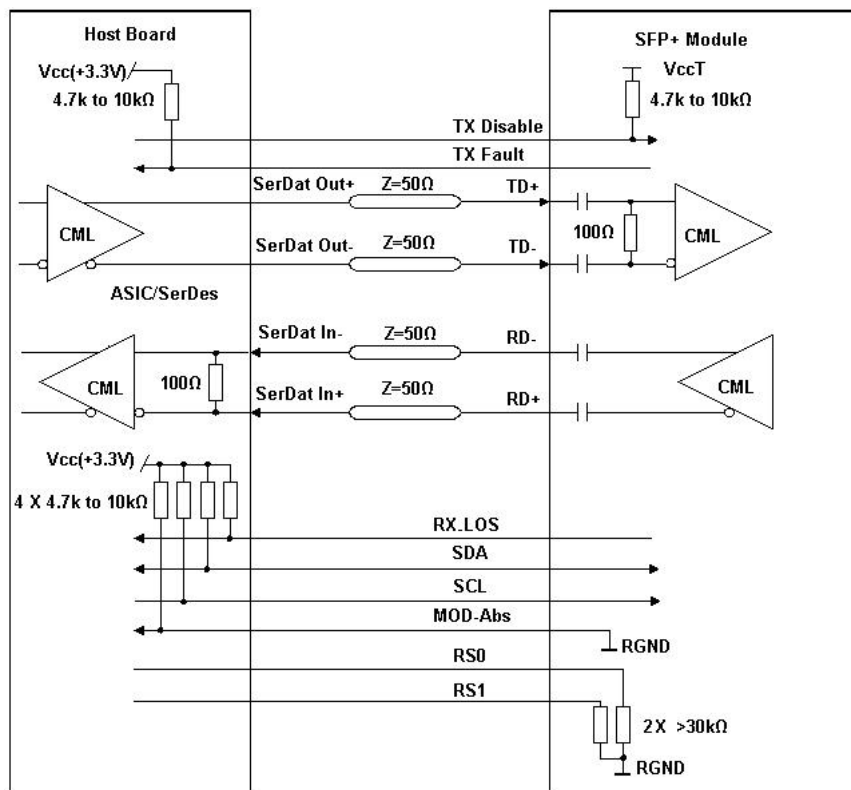

Figure2: Recommended Interface Circuit

Pin-out Definition

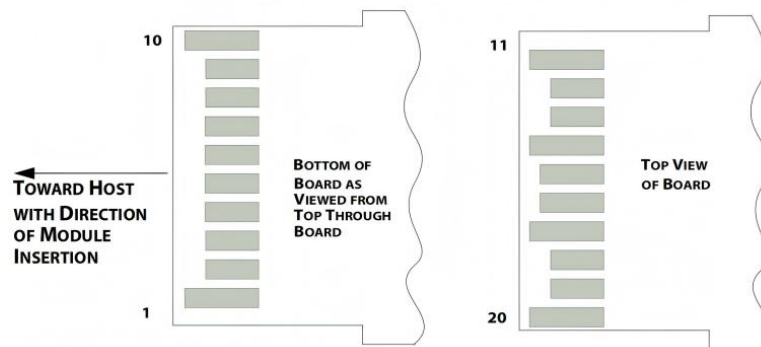

Figure3:Pin view

Pin Function Definitions

Pin	Logic	Symbol	Description	Note
1		VeeT	Module Transmitter Ground	1
2	LVTTL-O	TX_Fault	Module Transmitter Fault	2
3	LVTTL-I	TX_Disable	Transmitter Disable; Turns off transmitter laser output	3
4	LVTTL-I/O	SDA	2-wire Serial Interface Data Line (Same as MOD-DEF2 as defined in the INF-8074i)	4
5	LVTTL-I/O	SCL	2-wire Serial Interface Clock (Same as MOD-DEF1 as defined in the INF-8074i)	4
6		MOD_ABS	Module Absent, connected to VeeT or VeeR in the module	5
7	LVTTL-I	RS0	Adaptive multi-rate operation	6
8	LVTTL-O	RX_LOS	Receiver Loss of Signal Indication (In FC designated as RX_LOS, in SONET designated as LOS, and in Ethernet designated at Signal Detect)	2
9	LVTTL-I	RS1	Adaptive multi-rate operation	6
10		VeeR	Module Receiver Ground	1
11		VeeR	Module Receiver Ground	1
12	CML-O	RD-	Receiver Inverted Data Output	
13	CML-O	RD+	Receiver Non-Inverted Data Output	
14		VeeR	Module Receiver Ground	1
15		VccR	Module Receiver 3.3 V Supply	
16		VccT	Module Transmitter 3.3 V Supply	
17		VeeT	Module Transmitter Ground	1
18	CML-I	TD+	Transmitter Non-Inverted Data Input	
19	CML-I	TD-	Transmitter Inverted Data Input	
20		VeeT	Module Transmitter Ground	1

Note1:The module signal ground pins, VeeR and VeeT, shall be isolated from the module case.

Note2:This pin is an open collector/drain output pin and shall be pulled up with 4.7kΩ-10kΩ to Host_Vcc on the host board. Pull ups can be connected to multiple power supplies, however the host board design shall ensure that no module pin has voltage exceeding module VccT/R + 0.5V.

Note3:This pin is an open collector/drain input pin and shall be pulled up with 4.7kΩ-10kΩ to VccT in the module.

Note4:See SFF-8431 4.2 2-wire Electrical Specifications.

Note5:This pin shall be pulled up with 4.7kΩ-10kΩ to Host_Vcc on the host board.

Monitoring Specification

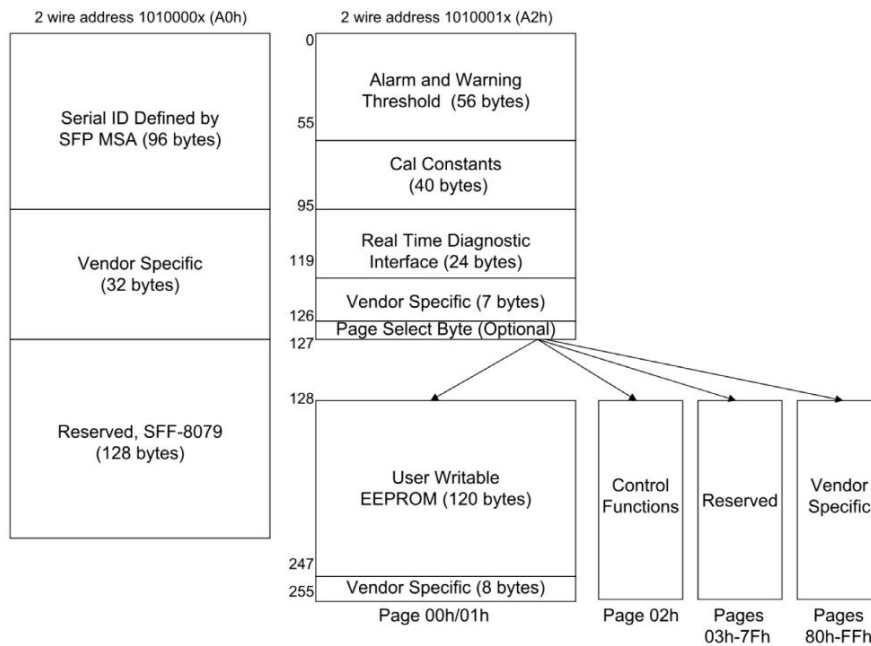

Figure4:Memory map

Memory map Table

A0h	Bytes	Name	Description
A0h ID Fields			
0	1	Identifier	Type of transceiver
1	1	Ext. Identifier	Extended identifier of type of transceiver
2	1	Connector	Code for connector type
3-10	8	Transceiver	Code for electronic or optical compatibility
11	1	Encoding	Code for high speed serial encoding algorithm
12	1	Signaling Rate, Nominal	Nominal signaling rate, units of 100 MBd.
13	1	Rate Identifier	Type of rate select functionality
14	1	Length (SMF,km) or Copper Cable Attenuation	Link length supported for single-mode fiber, units of km, or copper cable attenuation in dB at 12.9 GHz

15	1	Length (SMF) or Copper Cable Attenuation	Link length supported for single-mode fiber, units of 100 m, or copper cable attenuation in dB at 25.78 GHz
16	1	Length (50 um, OM2)	Link length supported for 50 um OM2 fiber, units of 10 m
17	1	Length (62.5 um, OM1)	Link length supported for 62.5 um OM1 fiber, units of 10 m
18	1	Length (OM4 or copper cable)	Link length supported for 50um OM4 fiber, units of 10 m. Alternatively, copper or direct attach cable, units of m
19	1	Length (OM3) or Cable length, additional	Link length supported for 50 um OM3 fiber, units of 10 m. Alternatively, copper or direct attach cable multiplier and base value
20-35	16	Vendor name	SFP vendor name (ASCII)
36	1	Transceiver	Code for electronic or optical compatibility
37-39	3	Vendor OUI	SFP vendor IEEE company ID
40-55	16	Vendor PN	Part number provided by SFP vendor (ASCII)
56-59	4	Vendor rev	Revision level for part number provided by vendor (ASCII)
60-61	2	Wavelength	Laser wavelength (Passive/Active Cable Specification Compliance)
62	1	Fibre Channel Speed 2	Transceiver's Fibre Channel speed capabilities
63	1	CC_BASE	Check code for Base ID Fields (addresses 0 to 62)
64-65	2	Options	Indicates which optional transceiver signals are implemented
66	1	Signaling Rate, max	Upper signaling rate margin, units of %
67	1	Signaling Rate, min	Lower signaling rate margin, units of %
68-83	16	Vendor SN	Serial number provided by vendor (ASCII)
84-91	8	Date code	Vendor's manufacturing date code
92	1	Diagnostic Monitoring Type	Indicates which type of diagnostic monitoring is implemented (if any) in the transceiver
93	1	Enhanced Options	Indicates which optional enhanced features are implemented (if any) in the transceiver
94	1	SFF-8472 Compliance	Indicates which revision of SFF-8472 the transceiver complies with.
95	1	CC_EXT	Check code for the Extended ID Fields (addresses 64 to 94)
96-127	32	Vendor Specific	Vendor Specific EEPROM
128-255	128	Reserved	Reserved (was assigned to SFF-8079)
A2h ID Fields			
00-01	2	Temp High Alarm	MSB at low address
02-03	2	Temp Low Alarm	MSB at low address
04-05	2	Temp High Warning	MSB at low address
06-07	2	Temp Low Warning	MSB at low address
08-09	2	Voltage High Alarm	MSB at low address
10-11	2	Voltage Low Alarm	MSB at low address
12-13	2	Voltage High Warning	MSB at low address
14-15	2	Voltage Low Warning	MSB at low address
16-17	2	Bias High Alarm	MSB at low address

18-19	2	Bias Low Alarm	MSB at low address
20-21	2	Bias High Warning	MSB at low address
22-23	2	Bias Low Warning	MSB at low address
24-25	2	TX Power High Alarm	MSB at low address
26-27	2	TX Power Low Alarm	MSB at low address
28-29	2	TX Power High Warning	MSB at low address
30-31	2	TX Power Low Warning	MSB at low address
32-33	2	RX Power High Alarm	MSB at low address
34-35	2	RX Power Low Alarm	MSB at low address
36-37	2	RX Power High Warning	MSB at low address
38-39	2	RX Power Low Warning	MSB at low address
40-41	2	Optional Laser Temp High Alarm	MSB at low address
42-43	2	Optional Laser Temp Low Alarm	MSB at low address
44-45	2	Optional Laser Temp High Warning	MSB at low address
46-47	2	Optional Laser Temp Low Warning	MSB at low address
48-49	2	Optional TEC Current High Alarm	MSB at low address
50-51	2	Optional TEC Current Low Alarm	MSB at low address
52-53	2	Optional TEC Current High Warning	MSB at low address
54-55	2	Optional TEC Current Low Warning	MSB at low address
56-91	36	Ext Cal Constants or Additional Enhanced Features	Diagnostic calibration constants for optional External Calibration if External Calibration bit, A0h, byte 92, bit 4 is 1 Additional Enhanced Features advertisement, control and status if External Calibration bit, A0h, byte 92, bit 4 is 0
92-94	3	Reserved	
95	1	CC_DMI	Check code for Base Diagnostic Fields (addresses 0 to 94)
96-105	10	Diagnostics	Diagnostic Monitor Data (internally or externally calibrated)
106-109	4	Optional Diagnostics	Monitor Data for Optional Laser temperature and TEC current
110	1	Status/Control	Optional Status and Control Bits
111	1	Reserved	Reserved (was assigned to SFF-8079)
112-113	2	Alarm Flags	Diagnostic Alarm Flag Status Bits
114	1	Tx Input EQ control	Tx Input equalization level control
115	1	Rx Out Emphasis control	Rx Output emphasis level control
116-117	2	Warning Flags	Diagnostic Warning Flag Status Bits
118-119	2	Ext Status/Control	Extended module control and status bytes
120-126	7	Vendor Specific	Vendor specific memory addresses
127	1	Table Select	Optional Page Select
A2h Page 00-01h			
128-247	120	User EEPROM	User writable non-volatile memory

248-255	8	Vendor Control	Vendor specific control addresses
A2h Page 02h			
128-129	2	Reserved	Reserved for SFF-8690 (Tunable Transmitter)
130	1	Reserved	Reserved for future receiver controls
131	1	Rx Decision Threshold	RDT value setting
132-172	41	Reserved	Reserved for SFF-8690
173-255	83	Reserved	Reserved

Mechanical Dimension

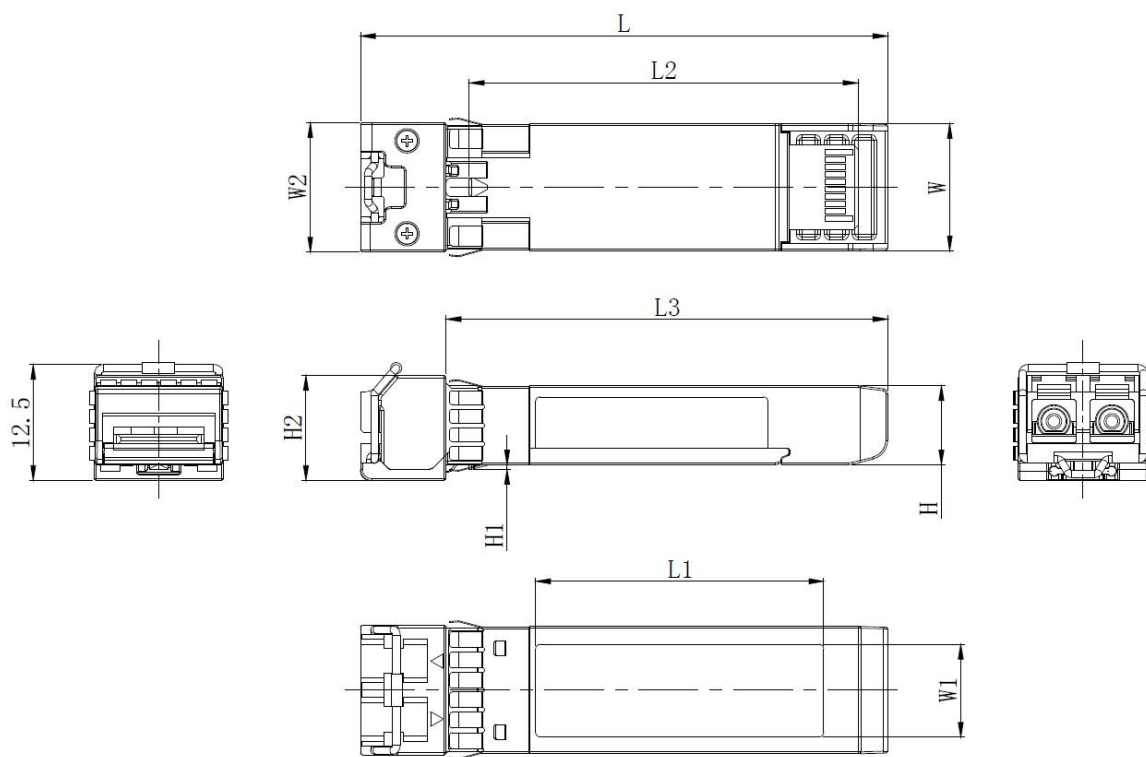

Unit: mm

	L	L1	L2	L3	W	W1	W2	H	H1	H2
MAX	56.9	31.2	41.95	47.7	13.8	10.2	14.0	8.6	0.6	11.5
Typical	56.7	31.0	41.80	47.5	13.7	10.0	-	8.5	0.5	11.3
MIN	56.5	30.8	41.65	47.3	13.5	9.8	-	8.4	0.4	11.1

Test Center

1、Performance Testing

Every fiber optic transceiver is thoroughly tested by the LSOLINK Assurance Program, which is equipped with the world's most advanced analytical equipment to ensure that our transceivers meet the industry's international public protocol standards while still functioning flawlessly in your facility.

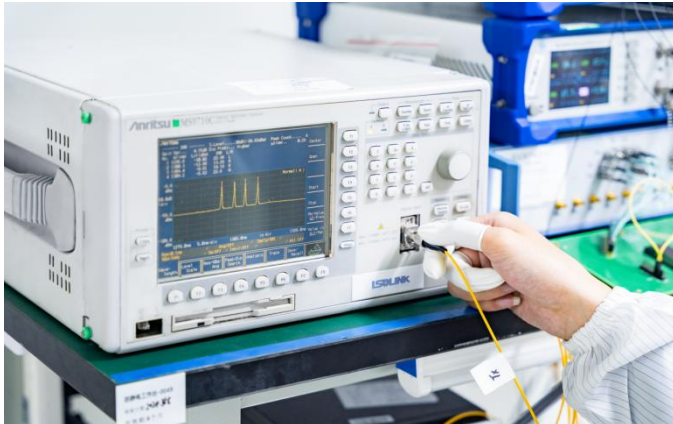

Optical Spectrum Inspection

Using the industry's leading optical spectrum analyser to check in real time that the parameters of the optical transceiver's laser comply with industry standards.

- **Peak:** Peak wavelength and peak level
- **2nd Peak:** Side-mode wavelength and level
- **Mean Wl:** Center wavelength
- **Total Power:** Total power of spectrum
- **SMSR:** Side-Mode Suppression Ratio



Optical Signal Quality Inspection

Using highly efficient sampling oscilloscopes and BERT testers, equipped with an automated test platform to accurately test the signal quality of the transceiver, test records are kept for up to 5 years to ensure the traceability of each transceiver.

- **Eye Mask Margin(NRZ)**
- **TDECQ(PAM4):** transmitter dispersion eye closure
- **OMA:** Optical modulation amplitude
- **BER:** Bit error rate
- **ER:** Extinction Ratio



Flow Pressure Test

Using multi-protocol network traffic analyser with various brands of switches to test the transceiver's ability to transmit at full speed.

- **Bandwidth:** Actual transceiver bandwidth on the port
- **Packet Loss**
- **Packet Errors:** CRC Errors/PCS Errors/Symbol Errors
- **LinkDown Counts**
- **latency**

Above is part of our test bed network equipment. For more information, Please click [download](#) for optical transceiver performance test report.

2、Quality Control

We adopt advanced quality management solutions. Each transceiver is self-inspected, including:20x microscope inspection, 200x microscope inspection, and QC process inspection.



visual inspection



Microscopic inspection: 20X



Microscopic inspection: 200X



Reliability Verification



Optical endface inspection



OQC Inspection

Order Information

Part Number	Description
25G-SFP-SR	25GBASE-SR SFP28 25G 850nm 100m DOM LC MMF Transceiver Module
25G-SFP-LR	25GBASE-LR SFP28 25G 1310nm 10km DOM LC SMF Transceiver Module
25G-SFP-ER	25GBASE-ER SFP28 25G 1310nm 40km DOM LC SMF Transceiver Module
10/25G-SFP-SR	10/25GBASE-SR SFP28 25G Dual rate 850nm 100m DOM LC MMF Transceiver Module
10/25G-SFP-LR	10/25GBASE-LR SFP28 25G Dual rate 1310nm 10km DOM LC SMF Transceiver Module

Further Information

 | Lighting the Path to Global Links

 **Web** | www.lsolink.com

 **Email** | For Sales@lsolink.com

Disclaimer

1. We are committed to continuous product improvement and feature upgrades, and the contents contained in this manual are subject to change without notice.
2. Nothing herein should be construed as constituting an additional warranty.
3. LSOLINK assumes no responsibility for the use or reliability of equipment or software not provided by LSOLINK. Copyright LSOLINK.COM All Rights